

### Isaro

A discrete and flexible road and street lantern with durable high performance. Programmable LED driver, set for fixed output, driving 36 LEDs at 850mA. Body: small size, die-cast aluminium (EN AC-44300), powder coated textured Light grey textured (150) - partly painted. Shaft: Light grey textured (150) - partly painted/unpainted. Cover: Extra White glass. Fixings: stainless steel with anti-galvanic treatment. narrow road optic, with Colour Rendering Index min.: 70, Correlated colour temperature\*: 3000 Kelvin LEDs supplied. Class I electrical, Impact strength: IK08, IP66, Ta max.: 35°C. Supplied with Ø60mm spigot adaptor which can be fitted for post-top (0°/5°/10° tilt) or side-entry (-20°/-15°/-10°/-5°/0° tilt). Pre-wired with 0.3m, 1.5mm<sup>2</sup> H07RN-F cable.

Dimensions: 550 x 238 x 157 mm  
 Luminaire input power: 93.9 W  
 Luminaire luminous flux: 12992 lm  
 Luminaire efficacy: 138 lm/W  
 Weight: 4.6 kg  
 Scx: 0.041 m<sup>2</sup>



TLG\_ISLC\_F\_S\_ZU\_SR.jpg

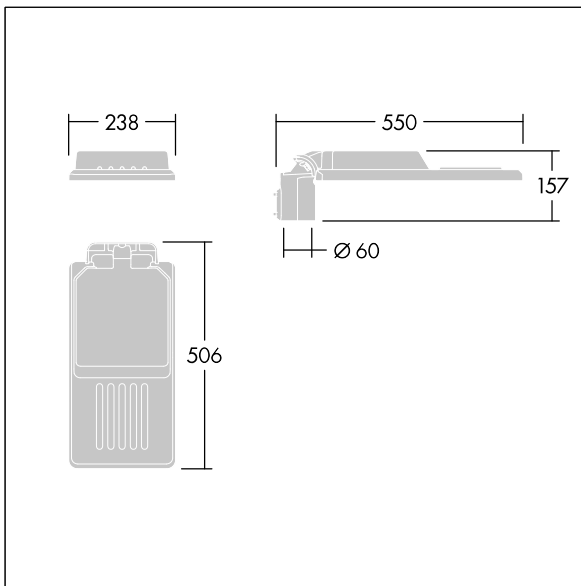

TLG\_ISLC\_M\_SMTp60.wmf

This product contains a light source of energy efficiency class D.

**Isaro**

**96636145 IS S 36L85-730 NR CL1 WS0.3 M60 GY-S**

**THORN**