

# Urba

96671798 UA 60L50-740 NR CL1 T60E ANT

THORN

## Urba

A large size LED urban street lighting lantern with 60 LEDs driven at 500mA with narrow road optic. Electronic, fixed output control gear. Class I electrical, IP66, Impact strength: IK09. Body: die-cast aluminium (EN AC-44300), textured anthracite. Cover: tempered flat clear glass. Fixings: stainless steel with anti-galvanic treatment. Post top mounting to Ø60mm column. Complete with 4000K LED.

Surge protection: 10kV single pulse common mode and 8kV multipulse common mode and 6kV multipulse differential mode. If permanent DALI system is connected, 6kV multipulse common and differential mode.

Dimensions: 1078 x 400 x 357 mm

Luminaire input power: 89 W

Weight: 16 kg

Scx: 0.11 m<sup>2</sup>



TLG\_URBA\_F\_LMTPGYPDB.jpg

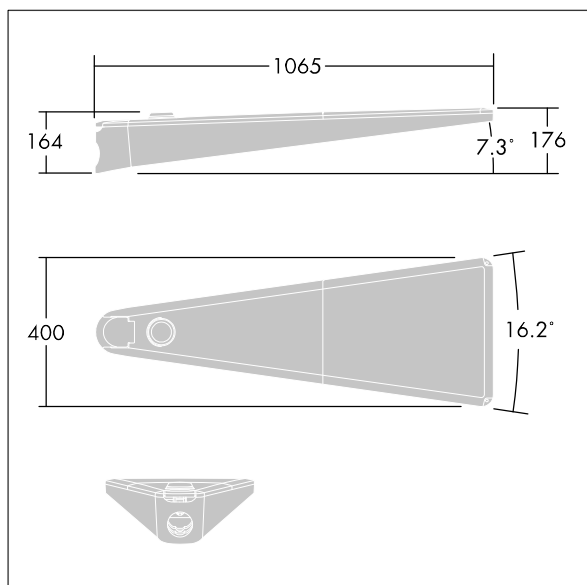

TLG\_URBA\_M\_LD1.wmf

This product contains light sources of energy efficiency class D.

All values marked with an \* are rated values. Thorn uses tried and tested components from leading suppliers, however there may be isolated instances of technology-related failures of individual LEDs during the rated product lifetime. International standards set the tolerance in initial flux and connected load at  $\pm 10\%$ . Unless stated otherwise, the values apply to an ambient temperature of 25°C.

Thorn Lighting is constantly developing and improving its products. The right is reserved to change specifications without prior notification or public announcement.  
© Thorn Lighting