

## Flow

96635501 FW 12L50-740 NR CL2 T60F ANT

### Flow

A highly versatile LED lantern with a Narrow Road, asymmetric distribution. Electronic, fixed output control gear driving 12 LEDs at 500mA. Compatible with PL, LRT, 7 pin Nema socket. Class II electrical, IP66, IK10. Housing, canopy and spigot: die-cast aluminium (EN AC-47100) powder coated anthracite (close to RAL7043).. Enclosure: 6mm thick clear glass.. Complete with 4000K LED. Post top mounting to Ø60mm column, tilt 5°, adjustable from 0° to +10°.

Surge protection: 10kV single pulse common mode and 8kV multipulse common mode and 6kV multipulse differential mode. If permanent DALI system is connected, 6kV multipulse common and differential mode.

Dimensions: 435 x 436 x 200 mm  
 Luminaire input power: 20 W  
 Luminaire luminous flux: 2793 lm  
 Luminaire efficacy: 140 lm/W  
 Weight: 8 kg  
 Scx: 0.054 m<sup>2</sup>



TLG\_FLOW\_F\_MTP\_CL.jpg

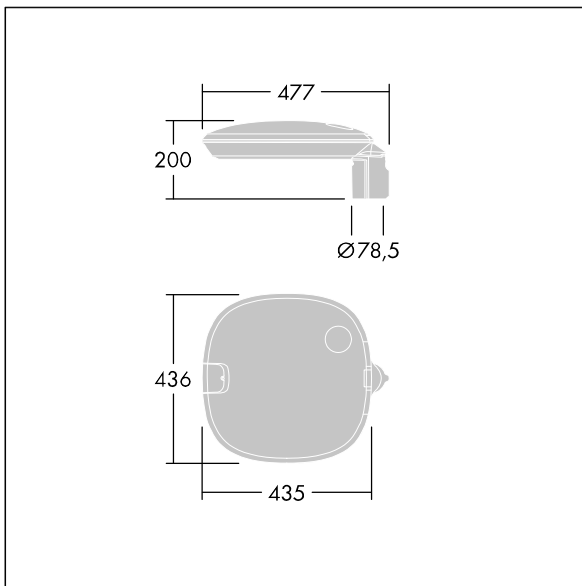

TLG\_FLOW\_M\_MTP60.wmf

This product contains a light source of energy efficiency class D.

**Flow**

**96635501 FW 12L50-740 NR CL2 T60F ANT**

**THORN**