

# PopPack

96634321 POPPACK LED 2300-840 HF L600

THORN

## PopPack

Batten LED luminaire. Electronic, fixed output control gear.  
Body: coated, formed steel, white (RAL9016). End caps:  
injection moulded polycarbonate,. Diffuser: textured opal  
acrylic. Electrical connection via 3 x 2 x 2.5mm<sup>2</sup> terminal  
block. Complete with 4000K LED

Dimensions: 610 x 60 x 74 mm  
Luminaire input power: 16.9 W  
Luminaire luminous flux: 2300 lm  
Luminaire efficacy: 136 lm/W  
Weight: 0.74 kg



TLG\_POPL\_F\_PDB\_EMPTY.jpg

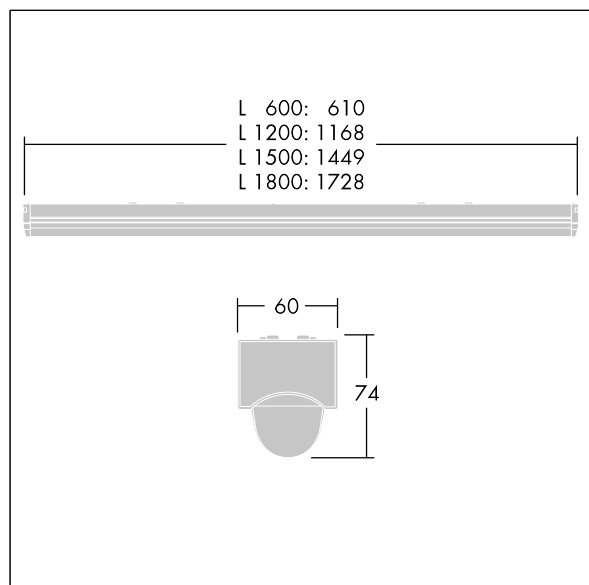

TLG\_POPL\_M\_LD1.wmf

This product contains a light source of energy efficiency class D.

All values marked with an \* are rated values. Thorn uses tried and tested components from leading suppliers, however there may be isolated instances of technology-related failures of individual LEDs during the rated product lifetime. International standards set the tolerance in initial flux and connected load at  $\pm 10\%$ . Unless stated otherwise, the values apply to an ambient temperature of 25°C.

Thorn Lighting is constantly developing and improving its products. The right is reserved to change specifications without prior notification or public announcement.  
© Thorn Lighting