

Contrast

96633693 CONT3 36L105-722-840 NB HFX 6K ANT

Contrast

A large architectural Bracket mounted LED floodlight with 36 LEDs driven at 1050mA and a narrow beam distribution. LED driver, DALI-2 dimmable. Class II electrical, IP66, IK08. Body: die-cast, powder coated, textured anthracite (close to RAL7043). Compatible with coastal environments. Glass: tempered, 5mm thick. Gasket: EPDM. Screws: geomet. Equipped with 6kV surge protection device. Complete with 2200-4000K balanced white LEDs

Dimensions: Ø397 x 206 mm
 Luminaire input power: 118 W
 Luminaire luminous flux: 11427 lm
 Luminaire efficacy: 97 lm/W
 Weight: 13.1 kg



TLG_CON3_F_M_36L.jpg

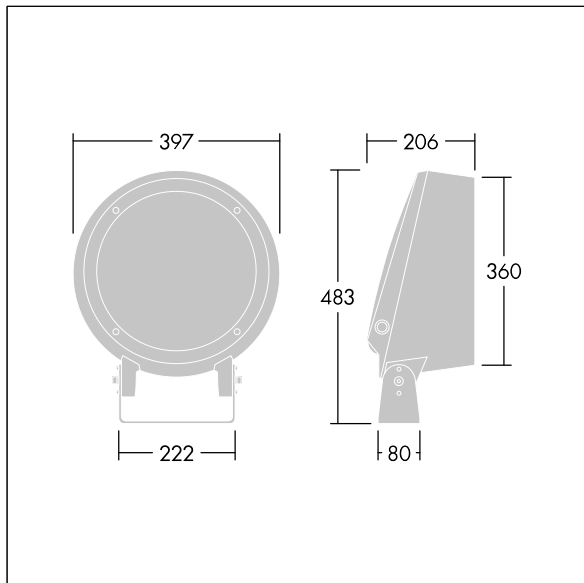

TLG_CONL_M_36-52L.wmf

This product contains a light source of energy efficiency class E.