

## Contrast

96633688 CONT3 4L50-822 MB HF ANT

### Contrast

A small architectural Bracket mounted LED floodlight with 4 LEDs driven at 500mA and a medium beam distribution. LED driver, Fixed output. Pre-wired. Class II electrical, IP66, IK08. Body: die-cast, powder coated, textured anthracite (close to RAL7043). Compatible with coastal environments. Glass: tempered, 5mm thick. Gasket: EPDM. Screws: geomet. Complete with 2200K LED

Dimensions: Ø83 x 103 mm  
 Luminaire input power: 8 W  
 Luminaire luminous flux: 299 lm  
 Luminaire efficacy: 37 lm/W  
 Weight: 0.91 kg



TLG\_CON3\_F\_XS.jpg

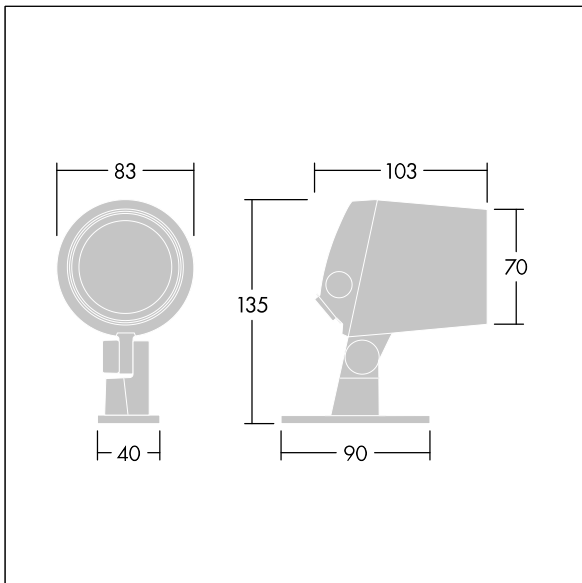

TLG\_CONL\_M\_4L.wmf

This product contains a light source of energy efficiency class G.

All values marked with an \* are rated values. Thorn uses tried and tested components from leading suppliers, however there may be isolated instances of technology-related failures of individual LEDs during the rated product lifetime. International standards set the tolerance in initial flux and connected load at  $\pm 10\%$ . Unless stated otherwise, the values apply to an ambient temperature of 25°C.

**Contrast**

**96633688 CONT3 4L50-822 MB HF ANT**

**THORN**