

Katona

96632222 KAT RD SE 1800-830 HF

THORN

Katona

A round functional LED luminaire with deep body for side entry wiring capability, can be used with up to Ø20mm surface mounted conduit. Fixed output LED driver. Body: polycarbonate. Diffuser: opal polycarbonate. Class II electrical, IP66, IK10. Complete with 3000K LED. Suitable for direct mounting to wall or ceiling. Loop-in, loop-out is possible for cables up to 2.5mm². BESA compatible.

Dimensions: Ø328 x 84 mm
Luminaire input power: 16.3 W
Luminaire luminous flux: 1650 lm
Luminaire efficacy: 101 lm/W
Weight: 1.5 kg

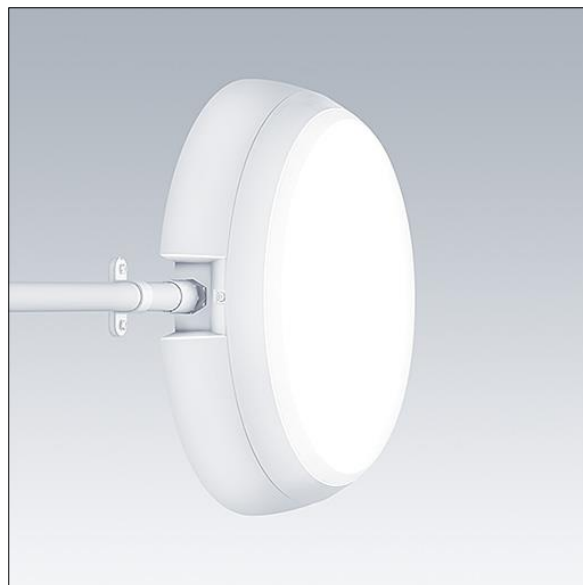

TLG_KATO_F_RD_deep_PDB.jpg

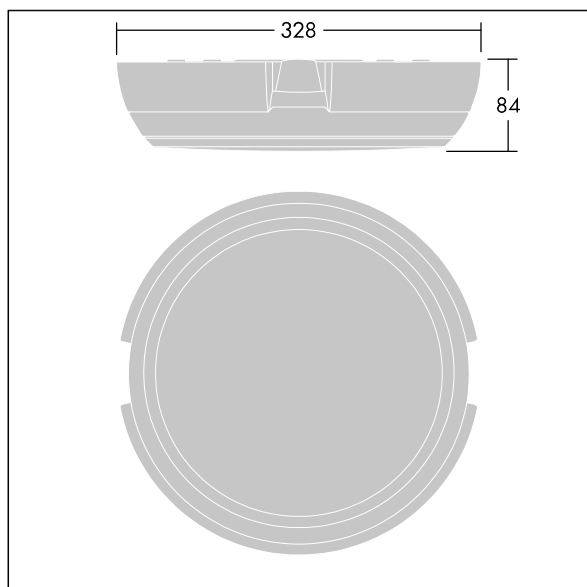

TLG_KATO_M_RD_FRAME_LDS.wmf

This product contains a light source of energy efficiency class D.

All values marked with an * are rated values. Thorn uses tried and tested components from leading suppliers, however there may be isolated instances of technology-related failures of individual LEDs during the rated product lifetime. International standards set the tolerance in initial flux and connected load at ±10%. Unless stated otherwise, the values apply to an ambient temperature of 25°C.

Thorn Lighting is constantly developing and improving its products. The right is reserved to change specifications without prior notification or public announcement.
© Thorn Lighting

Katona

96632222 KAT RD SE 1800-830 HF

THORN