

Zeta Pro G2

22666424 ZETA PRO G2 240W 740 150X70 CL1 10kV

THORN

Zeta Pro G2

Pole mounted LED streetlight. Body: die-cast aluminium. Diffuser: polycarbonate. Special lens suitable for street lighting applications. 220VAC, 50/60Hz. 10kV surge protection, IP66, IK08, Class I electrical. Complete with 4000K LED

Dimensions: 754 x 310 x 118 mm
Luminaire input power: 236.2 W
Luminaire luminous flux: 25720 lm
Luminaire efficacy: 109 lm/W
Weight: 9.5 kg



TLG_ZETA_F_PDB4.jpg

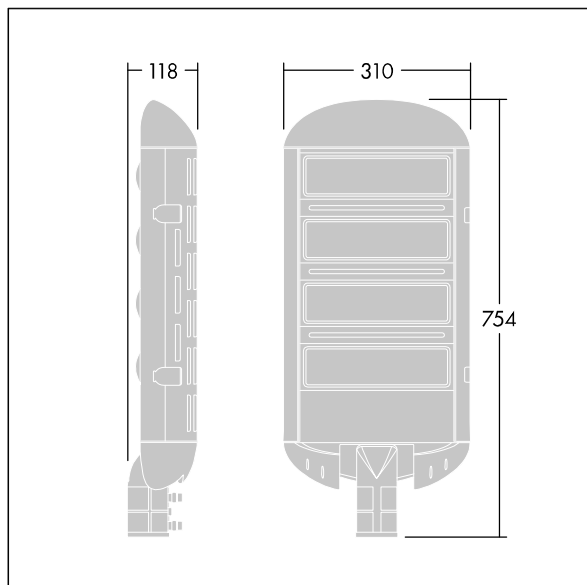

TLG_ZETA_M_LD4.wmf

All values marked with an * are rated values. Thorn uses tried and tested components from leading suppliers, however there may be isolated instances of technology-related failures of individual LEDs during the rated product lifetime. International standards set the tolerance in initial flux and connected load at $\pm 10\%$. Unless stated otherwise, the values apply to an ambient temperature of 25°C.

Thorn Lighting is constantly developing and improving its products. The right is reserved to change specifications without prior notification or public announcement.
© Thorn Lighting

Zeta Pro G2

22666424 ZETA PRO G2 240W 740 150X70 CL1 10kV

THORN