

PopPack

96631545 POPPACK LED 4500-840 HFI E3 L1200

THORN

PopPack

Batten LED luminaire. Electronic, DALI dimmable control gear with 3 hour, manual test, emergency lighting circuit. Body: coated, formed steel, white (RAL9016). End caps: injection moulded polycarbonate, white. Diffuser: textured opal acrylic. Electrical connection via (3 + 3) x 2 x 2.5mm² terminal block. Complete with 4000K LED

Dimensions: 1168 x 60 x 74 mm
Luminaire input power: 35.6 W
Luminaire luminous flux: 4650 lm
Luminaire efficacy: 131 lm/W
Weight: 2 kg



TLG_POPL_F_PDB_EMPTY.jpg

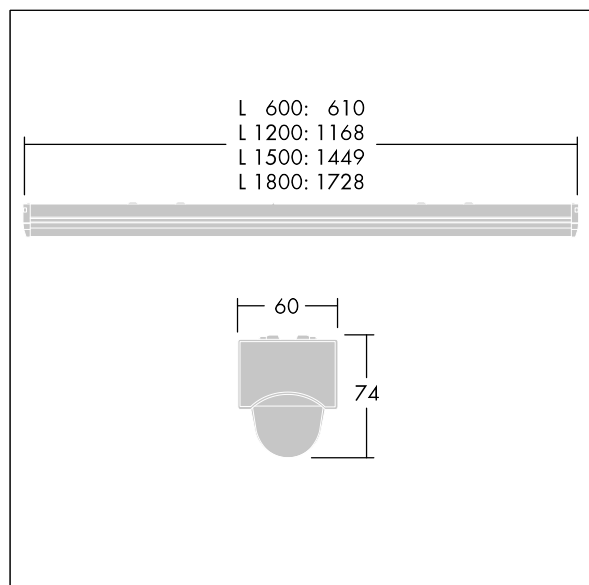

TLG_POPL_M_LD1.wmf

This product contains a light source of energy efficiency class D.

All values marked with an * are rated values. Thorn uses tried and tested components from leading suppliers, however there may be isolated instances of technology-related failures of individual LEDs during the rated product lifetime. International standards set the tolerance in initial flux and connected load at $\pm 10\%$. Unless stated otherwise, the values apply to an ambient temperature of 25°C.

Thorn Lighting is constantly developing and improving its products. The right is reserved to change specifications without prior notification or public announcement.
© Thorn Lighting