

Tonpak

22666314 TONPAK LED G2 50W 840 100X50 CL1

THORN

Tonpak

A high performance LED floodlight designed to cover general purpose area lighting and sports applications. Body and frame: die-cast aluminium, painted grey (RAL9006). Lens: PC with 4mm thick toughened glass. Class I electrical. High impact resistance IP66, IK08. Complete with 4000K LED.

Dimensions: 349 x 285 x 67 mm

Luminaire input power: 49.6 W

Total luminous flux: 5926 lm

Luminaire efficacy: 119 lm/W

Weight: 4.5 kg



TLG_TONP_F_FRONT_S.jpg

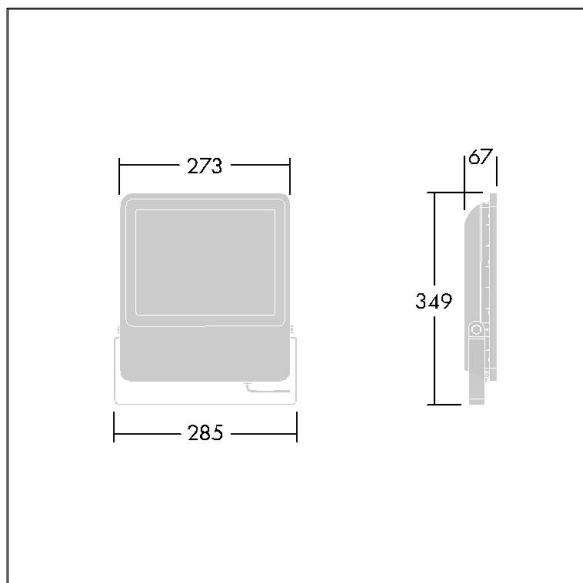

TLG_TONP_M_LDS.wmf

All values marked with an * are rated values. Thorn uses tried and tested components from leading suppliers, however there may be isolated instances of technology-related failures of individual LEDs during the rated product lifetime. International standards set the tolerance in initial flux and connected load at $\pm 10\%$. Unless stated otherwise, the values apply to an ambient temperature of 25°C.

Thorn Lighting is constantly developing and improving its products. The right is reserved to change specifications without prior notification or public announcement.
© Thorn Lighting

Tonpak

22666314 TONPAK LED G2 50W 840 100X50 CL1

THORN