

## LED sports floodlight

A high powered LED floodlight with wide light distribution(s) for sports lighting applications. Electronic, DMX / DALI controllable gear driving 264 LEDs. Class I electrical, IP66, IK08. Body, Frame and Stirrup: die-cast aluminium painted dark sandy grey (close to RAL 7043). Stirrup fixed by a single bolt through Ø22mm hole or 105x17mm oblong hole, or by twin bolts through Ø15mm holes. Glass: 5mm toughened. Screws: Stainless steel.

Complete flickerfree operation for HDTV broadcasting. Tilttable LED modules allow optimisation of lighting designs. Precision aiming device is adjustable on top or bottom of LED modules (to be ordered separately). Complete with 4000K LED, Colour Rendering Index min.: 80.

Due to the unique calculation requirements of this product the photometric data is not provided here but design advice may be obtained from your local representative.

Weight: 23.1 kg

Scx: 0.33 m<sup>2</sup>

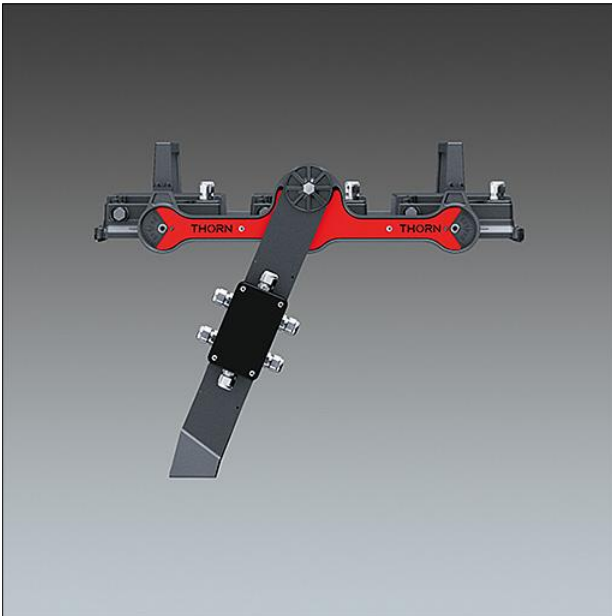

TLG\_ALSA\_F\_side.jpg

## Light Distribution