

Contus

96636075 CONTUS 10000-830 L2000 WB HF WH

THORN

Contus

An energy-efficient, linear continuous-row luminaire with 64 highly efficient mid-power LEDs per module with wide beam light distribution. Fixed output LED driver. Body: sheet steel coated with polyester lacquer finish, white. Class I electrical, IP20, IK07. All-in-one solution: lighting batten, lamp and reflector are combined in one product to produce a 100 % continuous LED light line without gaps or interruptions. The luminaire design fully matches the trunking to create a seamless system. Colour rendering Ra > 80, colour temperature 4000 K.

Please obtain advise from your local representative if you are planning to use the luminaire in environments containing chemical pollutants.

Dimensions: 1997 x 60 x 71 mm
Luminaire input power: 68.8 W
Luminaire luminous flux: 10130 lm
Luminaire efficacy: 147 lm/W
Weight: 2.76 kg

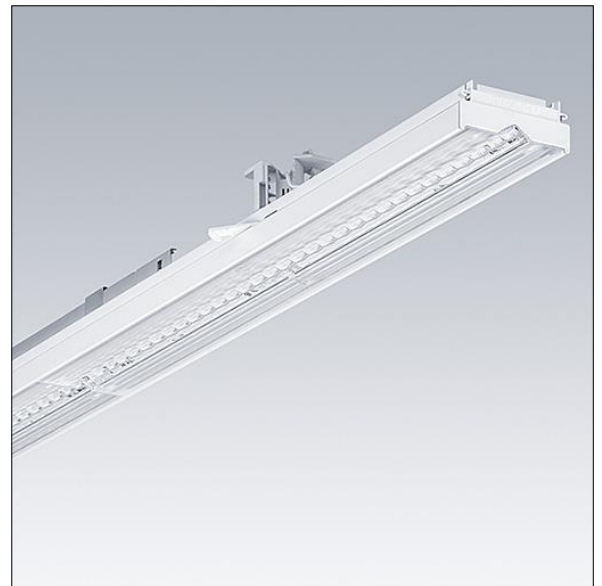

TLG_CONT_F_BATTEN.jpg

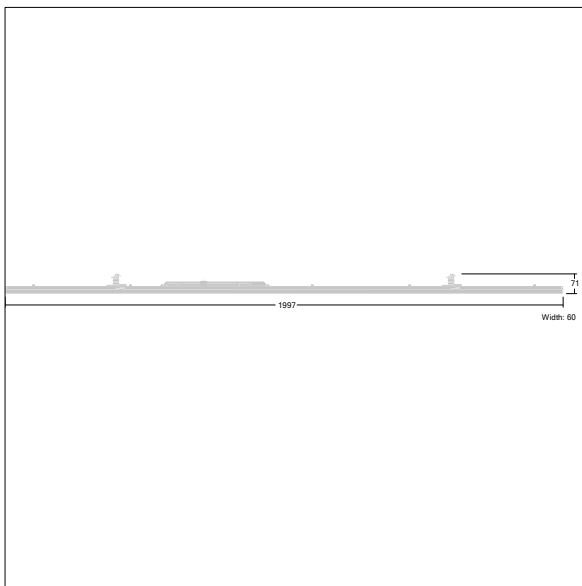

TL_CONTUS_M_L2000.wmf

This product contains a light source of energy efficiency class D.

All values marked with an * are rated values. Thorn uses tried and tested components from leading suppliers, however there may be isolated instances of technology-related failures of individual LEDs during the rated product lifetime. International standards set the tolerance in initial flux and connected load at $\pm 10\%$. Unless stated otherwise, the values apply to an ambient temperature of 25°C.

Thorn Lighting is constantly developing and improving its products. The right is reserved to change specifications without prior notification or public announcement.
© Thorn Lighting