

# Contus

96635807 CONTUS 5200-840 L1000 WB HF WH

THORN

## Contus

An energy-efficient, linear continuous-row luminaire with 64 highly efficient mid-power LEDs per module with wide beam light distribution. Fixed output LED driver. Body: sheet steel coated with polyester lacquer finish, white. Class I electrical, IP20, IK07. All-in-one solution: lighting batten, lamp and reflector are combined in one product to produce a 100 % continuous LED light line without gaps or interruptions. The luminaire design fully matches the trunking to create a seamless system. Colour rendering Ra > 80, colour temperature 4000 K.

Please obtain advise from your local representative if you are planning to use the luminaire in environments containing chemical pollutants.

Dimensions: 1000 x 60 x 71 mm  
Luminaire input power: 35.7 W  
Luminaire luminous flux: 5370 lm  
Luminaire efficacy: 150 lm/W  
Weight: 1.43 kg

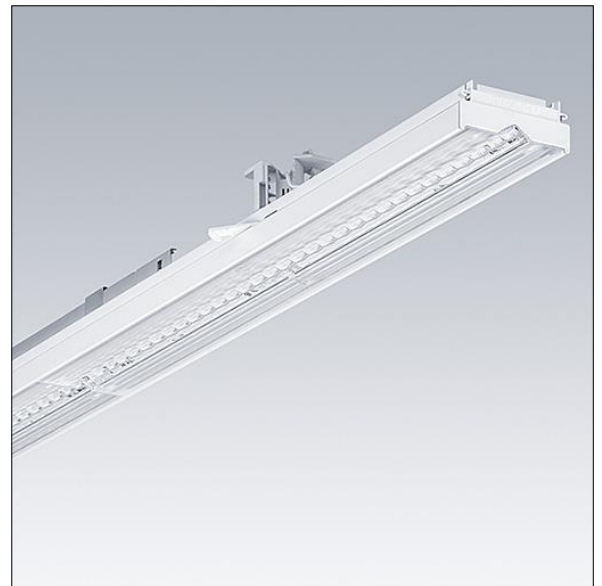

TLG\_CONT\_F\_BATTEN.jpg

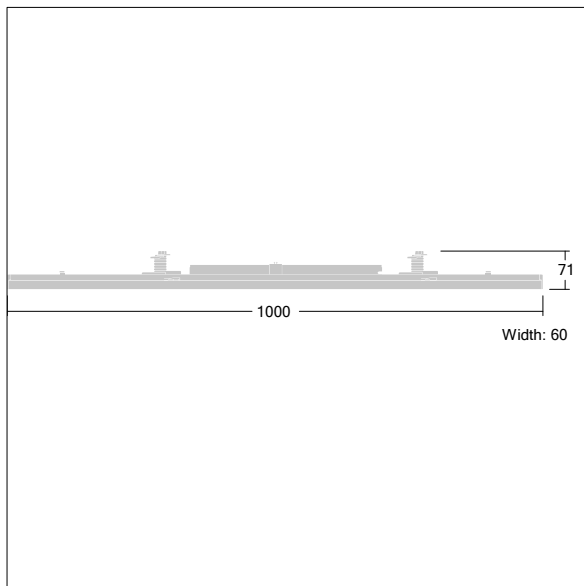

TL\_CONTUS\_M\_L1000.wmf

This product contains a light source of energy efficiency class D.

All values marked with an \* are rated values. Thorn uses tried and tested components from leading suppliers, however there may be isolated instances of technology-related failures of individual LEDs during the rated product lifetime. International standards set the tolerance in initial flux and connected load at  $\pm 10\%$ . Unless stated otherwise, the values apply to an ambient temperature of 25°C.

Thorn Lighting is constantly developing and improving its products. The right is reserved to change specifications without prior notification or public announcement.  
© Thorn Lighting

**Contus**

**96635807 CONTUS 5200-840 L1000 WB HF WH**

**THORN**