

Indubay

22666304 INDUBAY LED G2 LED12000-840 HF

THORN

Indubay

A pendant mounted circular LED high bay luminaire with Electronic, fixed output control gear. Heat sink: die-cast aluminium. Reflector: aluminium alloy. PC lens also offer a comfortable lighting effect. Surge protection: 4kV. Complete with 4000K LED.

Dimensions: Ø500 x 360 mm
Luminaire input power: 91.7 W
Luminaire luminous flux: 11416 lm
Luminaire efficacy: 124 lm/W
Weight: 3.2 kg



TLG_INDC_F_G2.jpg

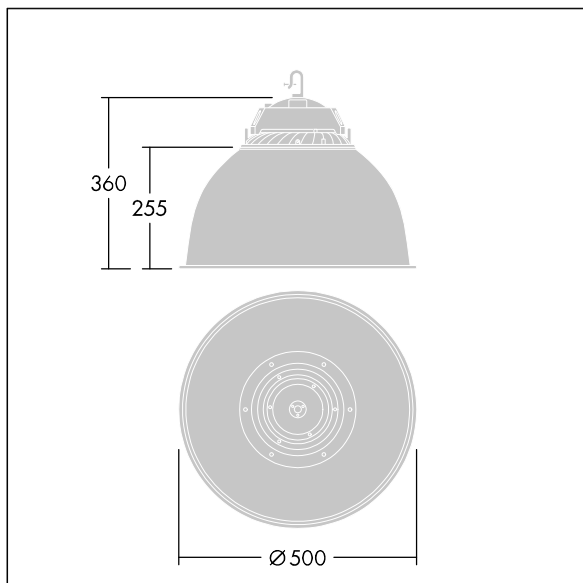

TLG_INDC_M_500D.wmf

All values marked with an * are rated values. Thorn uses tried and tested components from leading suppliers, however there may be isolated instances of technology-related failures of individual LEDs during the rated product lifetime. International standards set the tolerance in initial flux and connected load at $\pm 10\%$. Unless stated otherwise, the values apply to an ambient temperature of 25°C.

Thorn Lighting is constantly developing and improving its products. The right is reserved to change specifications without prior notification or public announcement.
© Thorn Lighting